

TECHNICAL DATA SHEET

RAXTAR of the Netherlands is a privately owned organization that provides world class vertical access solutions: construction hoists for passengers & materials, material hoists, transport platforms and industrial lifts. RAXTAR builds on innovation & technology to deliver unequalled operational reliability at the lowest total cost of ownership (TCO) in the market. RAXTAR is a synonym for meeting the highest quality- and safety standards.



RX2745HF Passenger & Material Hoist

TECHNICAL DATA*

CAPACITY

Payload	: 2700 kg	6000 lb
Lifting speed	: 0 – 72 m / min	0 – 236 ft / min
Counter weight	: No	No
Maximum lifting height	: 200 m	660'

DIMENSIONS & WEIGHT

Hoist car internal dimensions (l x w x h)	: 4.40 x 1.52 x 2.60 m	14' 5" x 5' x 8' 6"
Ground enclosure (l x w x h)	: 4.81 x 2.69 x 2.94 m	15' 9" x 9' 10" x 9' 8"
Length mast section	: 1.51 m	4' 11"
Weight mast section, single rack	: 120 kg	265 lb
Weight mast section, double rack	: 150 kg	330 lb

ELECTRICAL DATA

Motor	: 2x 22 kW	2x 22 kW
Power supply	: 400 V – 50 hz, 3p	460 V – 60 hz, 3p
110 V / 230 V power on platform	: Standard, included	Standard, included
Overload device	: Standard, included	Standard, included
Automatic lubrication	: Optional	Optional

HOIST CONTROLS

Controls	: Frequency control / SNL / PLC	Frequency control / SNL / PLC
User interface	: Joystick / touch panel	Joystick / touch panel
Blue tooth communication	: Optional	Optional
Manual controls / erection controls	: Standard, included	Standard, included
Drop test controls	: Standard, included	Standard, included
Programmable landings	: Optional	Optional
Hoist calling system	: Optional	Optional
RX Control, internet management control	: Optional	Optional

GENERAL

Finishing cabin / ground enclosure	: Galvanized / powder coated	Galvanized / powder coated
Company logo and color	: Optional	Optional
Ground enclosure	: Standard, included	Standard, included
C-door	: Optional	Optional
Cable trolley system	: Standard, included	Standard, included
Erection jib	: Optional	Optional
Norms & regulations	: Machine Directive (EN12159+A1) / A10.4:2007 (USA)	Machine Directive (EN12159+A1) / A10.4:2007 (USA)

RAXTAR

RX2745HF Passenger & Material Hoist

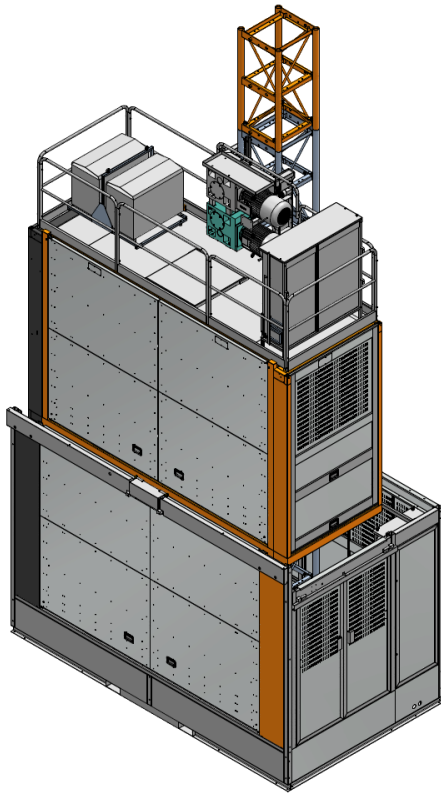

Overview

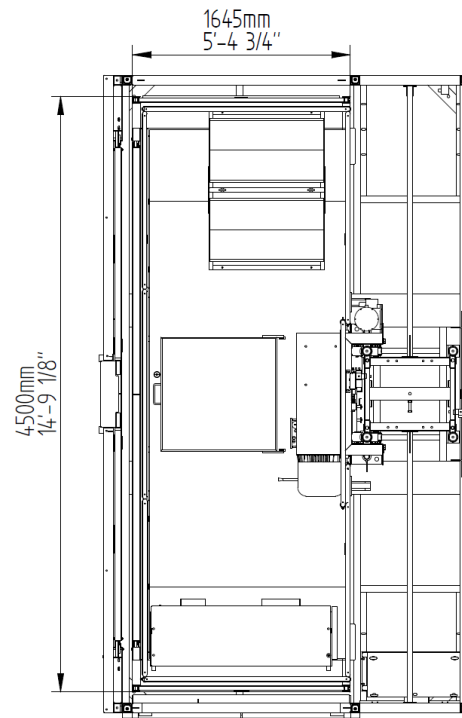

Top view

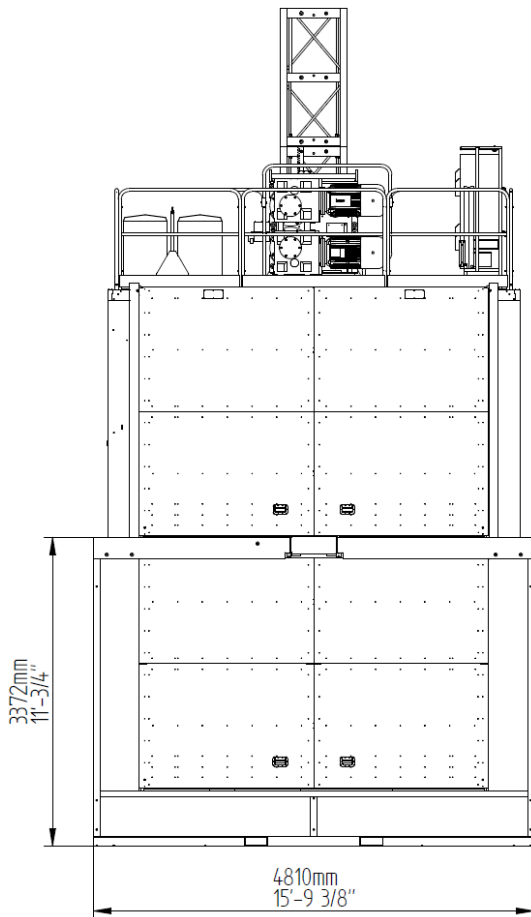

Side view

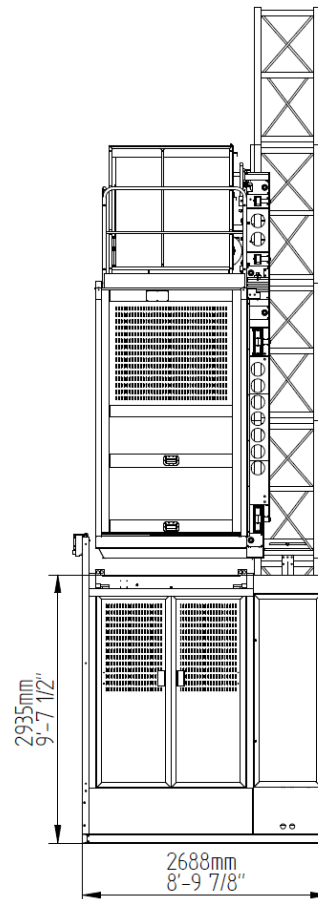

Front view

RAXTAR

RX2745HFT Passenger & Material Hoist (twin configuration)

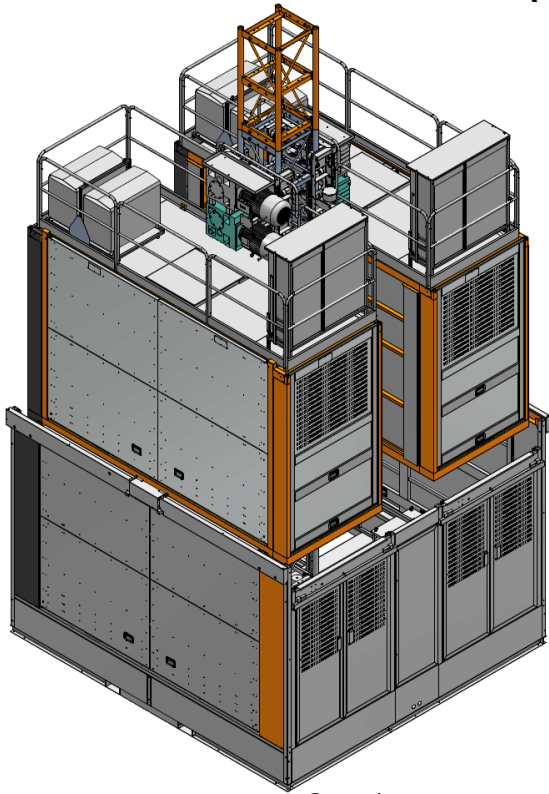

Overview

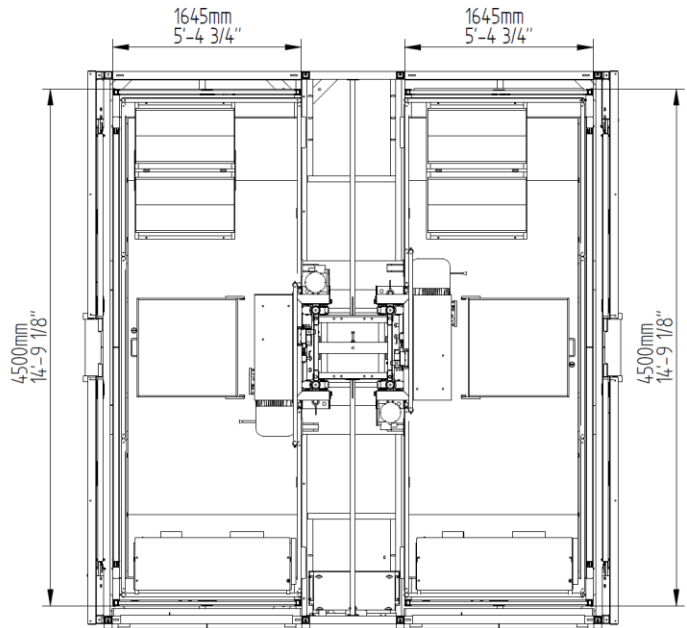

Top view

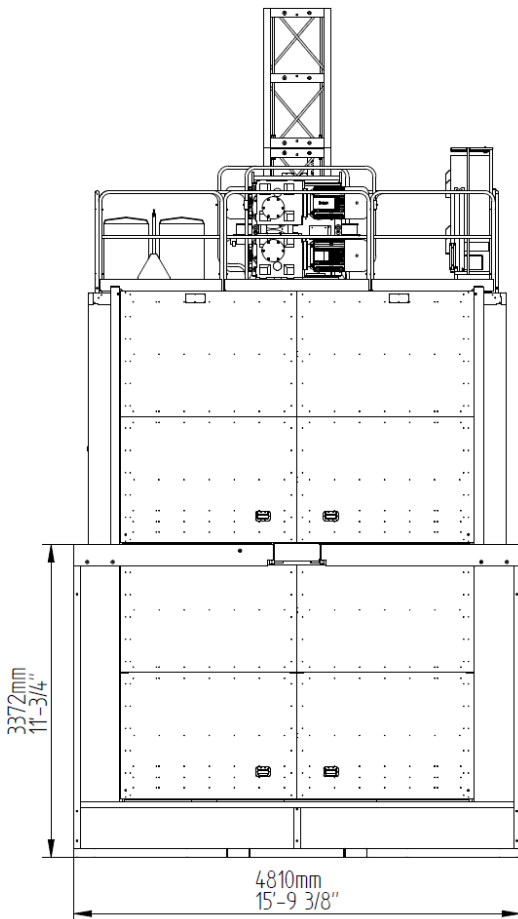

Side view

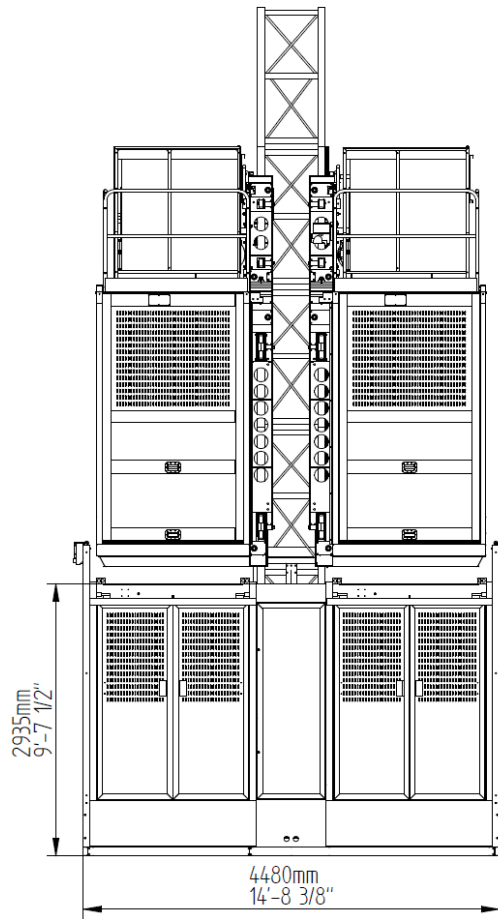

Front view